

# SP 4800 / SP 8800

Stationary concrete pumps



## OUTPUT AND DISTANCE TO MEET YOUR GOALS

- Output to 152 cu. yds./hr.
- Pressure to 2920 psi
- High Pressure Rock Valve

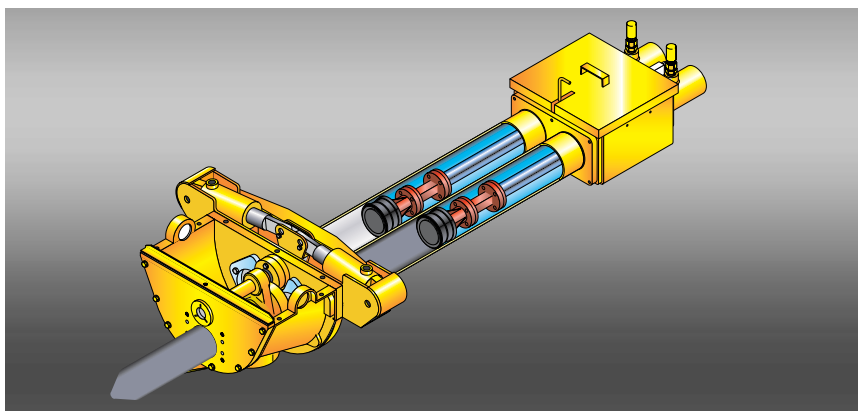

*This open loop Generation 3 all-hydraulic concrete pump sets the standard for fuel-efficiency, reliability and performance. Controlled acceleration of the differential cylinders reduces surge in the pipeline for smooth, quiet operation. Proven high pressure Rock Valve™ uses double shifting cylinders to pump the harshest mixes at the lowest operating cost.*



*Convenient control panel includes electric switches for on/off, forward/reverse and agitator on/off. Gauges monitor pumping pressure and rpm.*



When you are going to the top, choose the pumps that have already been there – the SP 4800 and SP 8800. These are the high pressure workhorse pumps that have topped out more high rise buildings than any others. The technology of our twin-cylinder, all-hydraulic open loop system concrete pump has been refined for decades along with the proven Rock Valve™ that is so important to reliability and cost of operation. The Rock Valve's design creates positive pressure within the valve which is ideal for high pressure pumping applications. As pressure from the concrete acts on the pressure spring, a tighter seal is created between the carbide cutting ring and the wear plate. This allows Schwing to pump at higher pressures with less maintenance.

Major pumping projects benefit from the Schwing experience that combines pumping expertise learned on record breaking projects along with unmatched factory support. This includes parts inventory at one of our six company branches strategically located throughout the United States and a staff of service technicians that can travel to your site 24/7.

So whether you are taking your mid-rise, high-rise or long distance project to completion, you have the experience of hundreds of successful projects behind you with Schwing.



*Remote control (cable or optional radio remote) frees the operator to monitor pumping progress. Critical functions include on/off and forward/reverse.*



*Fuel efficient Deutz diesel engine is chosen for performance and reliability. (SP 4800 6 cyl. 443 hp, SP 8800 8 cyl. 590 hp).*



*Fast cleanout with less wasted concrete is a benefit of these SP models over other valve types. Standard hopper agitator keeps concrete flowing to the material cylinders for smooth pumping of the harshest mixes.*

Only one manufacturer can supply the Schwing experience.

Thousands of our customers form a backdrop of success that you can join by letting us spec the right piece of equipment for your needs. Six company stores with technicians and parts placed strategically across the country provide service expertise as close as your phone. And a select group of knowledgeable dealers provides another layer of invaluable experience. You and your staff will be welcomed into our facility to learn how to extract the maximum profitability from your concrete pump.

Generations of successful owners have chosen the Schwing experience. As a third generation family owned company we understand how important quality equipment is to your business and how important your business is to us.



*More than 400,000 square feet are devoted to producing the highest quality concrete equipment at our [White Bear, Minnesota plant](#). From close inspection of incoming materials to forming our products with the latest robotic welding techniques, Schwing takes craftsmanship to the highest standards. Our state-of-the-art paint facility produces finished products you will be proud to put your name on. In addition, a vast inventory of parts are on hand to keep your Schwing product running at maximum efficiency. Please schedule a visit to this modern facility located minutes north of Minneapolis/St. Paul to see our long-term commitment to the market.*

# SPECIFICATIONS

## PUMP SPECIFICATIONS

PUMP SPECIFICATIONS	SP 4800		SP 4800		SP 8800		SP 8800	
	2018-5 150/90	2020-5 150/90	2018-7 150/90	2020-7 150/90	U.S. Rod/Piston	Metric Rod/Piston	U.S. Rod/Piston	Metric Rod/Piston
Concrete Output (cu. yds./hr. - cu. m./hr.)	86/56	66/43	106/69	81/53	123/82	94/63	152/101	116/77
Max. Pressure on Concrete (psi - bar)	1869/2920	129/201	1508/2364	104/163	1869/2920	129/201	1508/2364	104/163
Max. Strokes Per Minute	21	14	21	14	31	21	31	21
Pump Cylinder Diameter (in. - mm)	7	180	8	200	7	180	8	200
Pump Cylinder Stroke (in. - mm)	79	2000	79	2000	79	2000	79	2000
Differential Cylinder Size (in. - mm)	5.9	150	5.9	150	5.9	150	5.9	150
Maximum Aggregate Size (in. - mm)	2.5	64	2.5	64	2.5	64	2.5	64
Concrete Valve Type	High Pressure Rock with Double Shift Cylinders							
Hopper Capacity (cu. ft. - cu. m.)	21.5	.6	21.5	.6	21.2	.6	21.2	.6
Engine Power with CAT (hp. - kw.)	440	328	440	328	630	470	630	470
Axle	Single Axle Job Site Only							
Outrigger Legs	Manual		Manual		Hydraulic		Hydraulic	
Length (ft - mm)	23	7010	23	7010	27	8230	27	8230
Width (ft-in. - mm)	6-3	1905	6-3	1905	8	2438	8	2438
Height (ft-in. - mm)	8-1	2476	8-1	2476	8-8	2640	8-8	2640
Trailer Units Weight (lbs. - kg.)	17,637	8000	17,637	8000	22,000	9980	22,000	9980
Remote Control Cable (ft. - m.)	Cable-Pump Forward/Stop/Reverse/E-Stop							

Specifications are subject to change without prior notice.

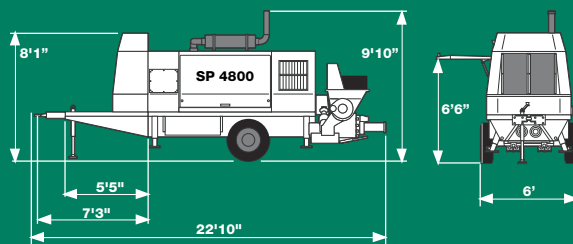
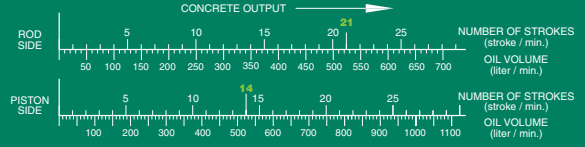
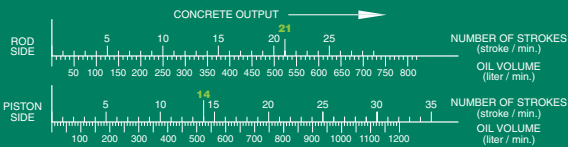
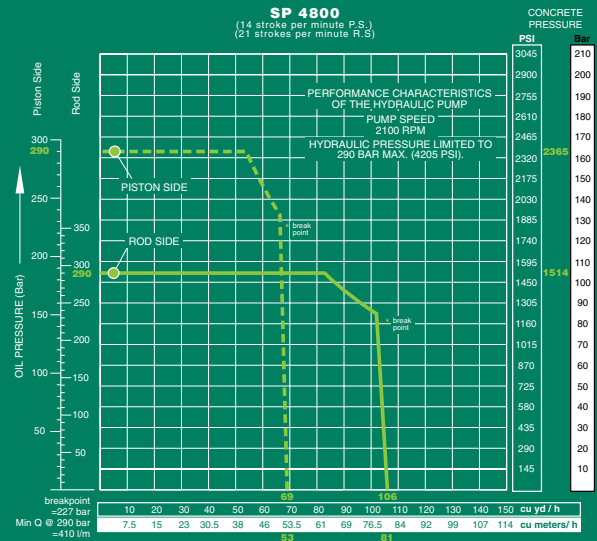
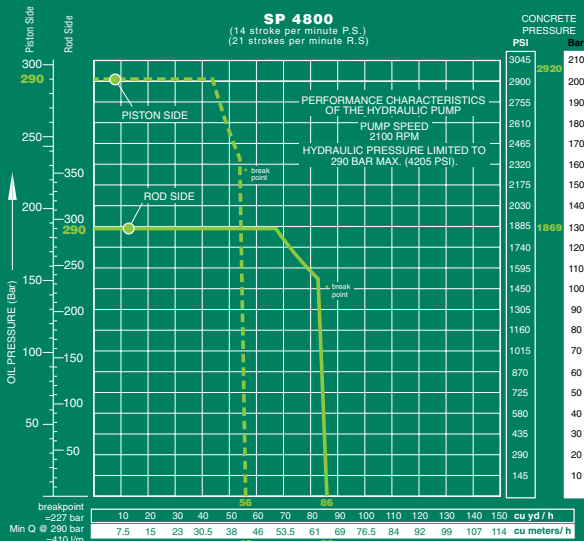

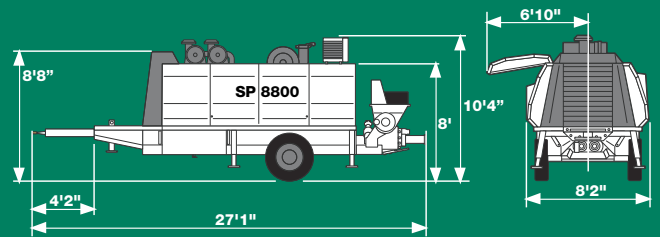
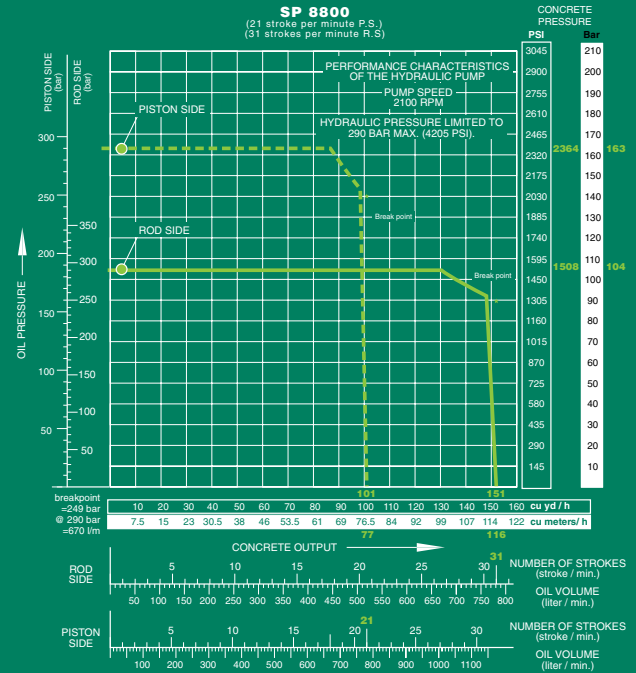
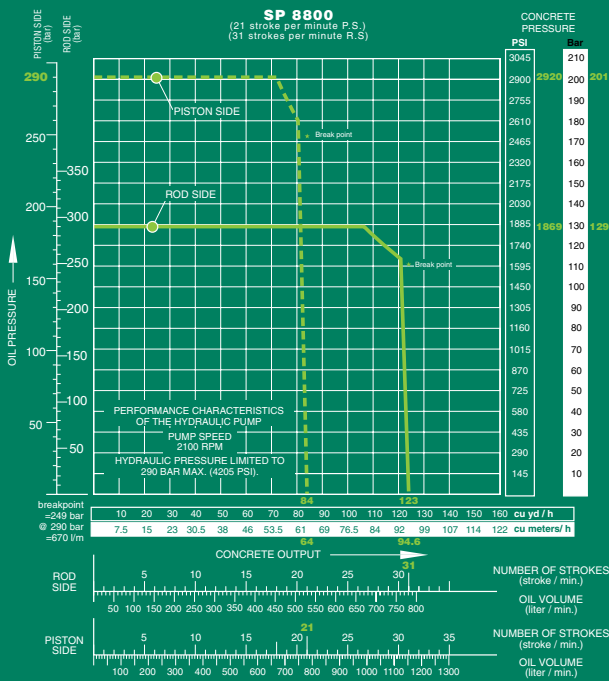

## SCHWING-STETTER MOVES CONCRETE. WORLDWIDE.

Wherever concrete is produced and moved is where you will find Schwing-Stetter machinery.

With plants in Germany, Austria, USA, Brazil, Russia, China and India as well as with more than 100 sales and service facilities, the group of companies is always close to the customer.

Our wide range of products with something for every application is what makes Schwing-Stetter the No. 1 system supplier for concrete machinery worldwide.



CONCRETE BATCHING PLANTS



TRUCK MIXERS



TRUCK-MOUNTED CONCRETE PUMPS



STATIONARY CONCRETE PUMPS



SEPARATE PLACING BOOMS



CONCRETE RECYCLERS

